

# AF/BC

AIRFOIL & BACKWARDLY CURVED

# FANS

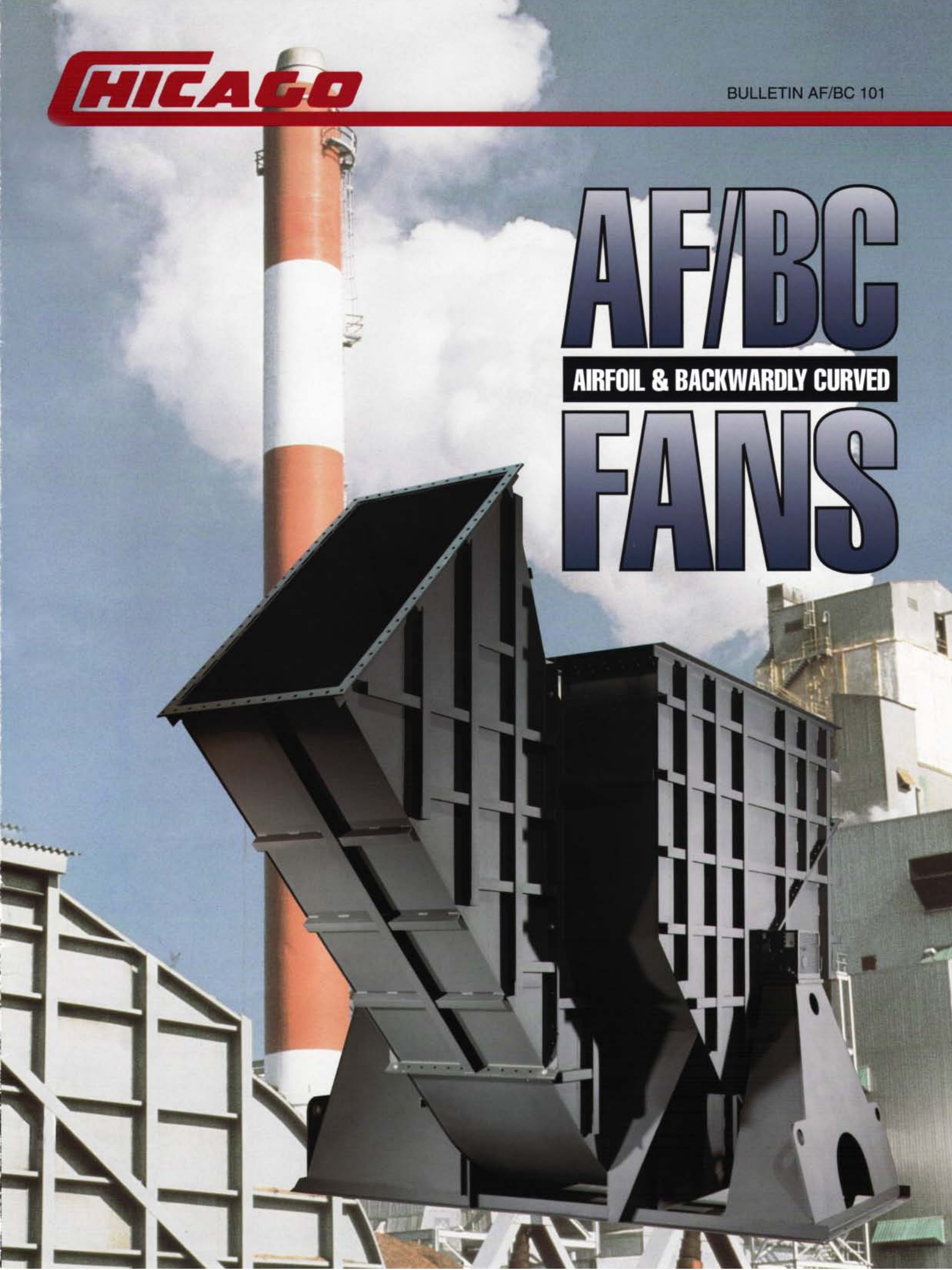



# CUSTOM HEAVY-DUTY FANS

## **Meets Industry Demands for Precise Performance at Maximum Efficiency**

The two most important criteria when specifying a custom heavy-duty fan are efficiency and reliability. Air handling systems are increasing in complexity with the addition of more restrictive emission controls and air cleaning devices. While the result has been a cleaner environment, system pressure requirements have risen significantly. As these requirements increase, greater levels of energy are needed to force the air or gas through the system. Operating efficiency of the fan has become much more critical. Every dollar saved on the purchase of a less efficient fan will be consumed in additional operating costs.

## **Preserving Our Energy for Generations to Come**

Maximum fan efficiency will not only have a positive impact on the bottom line, it will have a positive impact on the environment. Greater fan efficiency results in lower power requirements and fewer natural resources consumed. Efficiency also influences sound levels.

The more efficient fan will run quieter than the less efficient fan. The quieter fan will need less sound insulating materials, or none at all.

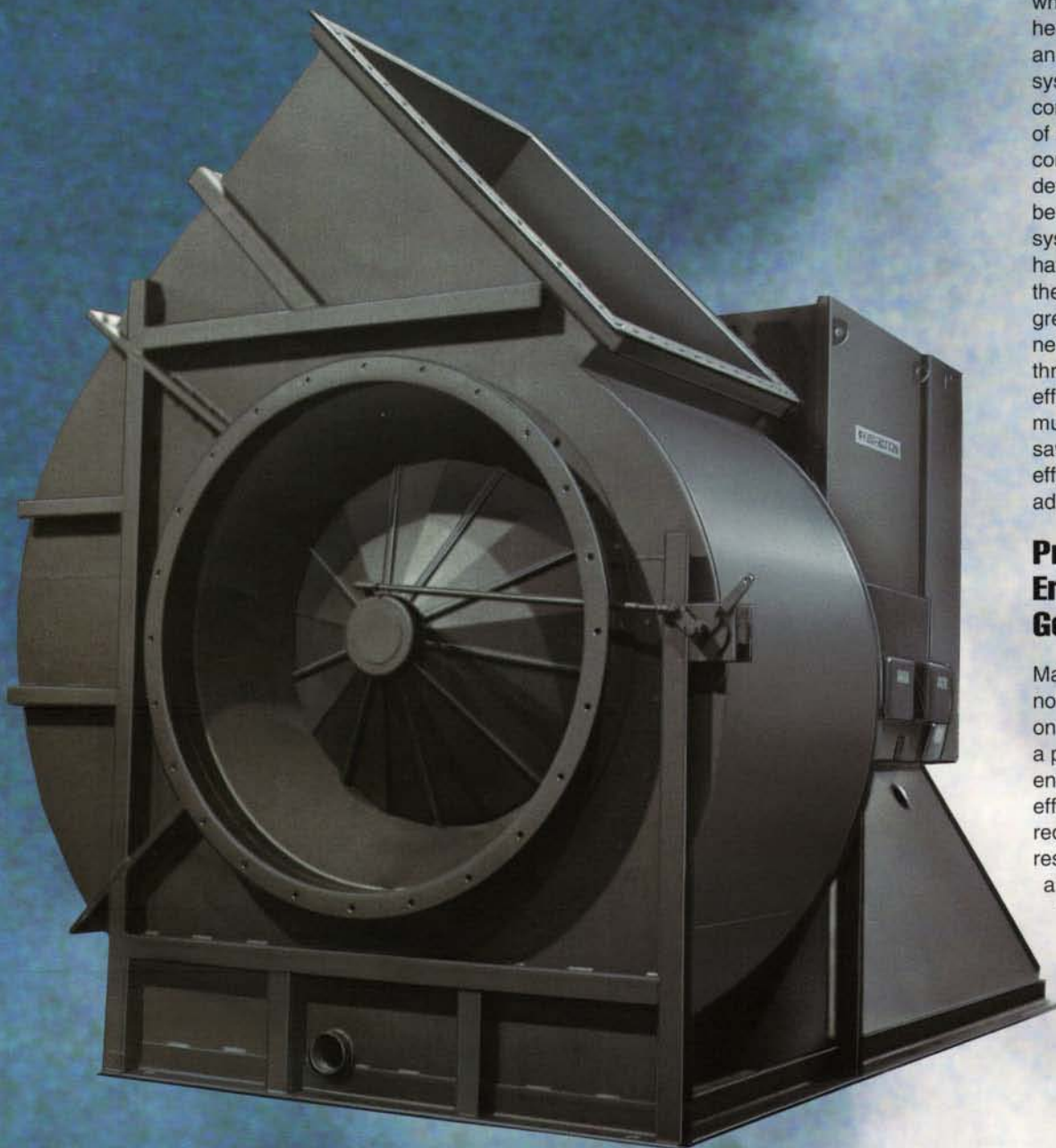

## Individually Computer Engineered and Sized

To cover the widest range of system requirements, Chicago offers a full family of airfoil and backwardly curved fan designs with overlapping performance envelopes. To maintain high efficiency and maximum economy, the system's pressure

and flow requirements are matched to one of eleven wheel designs with varying rotor widths and diameters. The selected fan is then sized to exact duty requirements. No more, no less.

Wheels are available with either Chicago's proven hollow airfoil blades for clean air, or solid backward curved or backward inclined blades for dusty, dirty applications. With

eleven rotor designs, custom sizing and duty matching blades, Chicago will build the fan to meet exact system performance specifications.

## Reliability Through Quality Assurance

A fan's operation is only as reliable as the quality that went into building that fan. For example, the use of AWS certified welders has enabled

Chicago to build heavy duty fans to the most demanding specifications. A strict Quality Assurance Program monitors every step in the fan building process and has helped Chicago Blower establish a solid reputation for fan reliability and corporate integrity. To assist system and process designers and specifiers select the right Chicago fan, Chicago Sales Offices are located nationwide and around the world.

### AIRFOIL BLADED DESIGNS

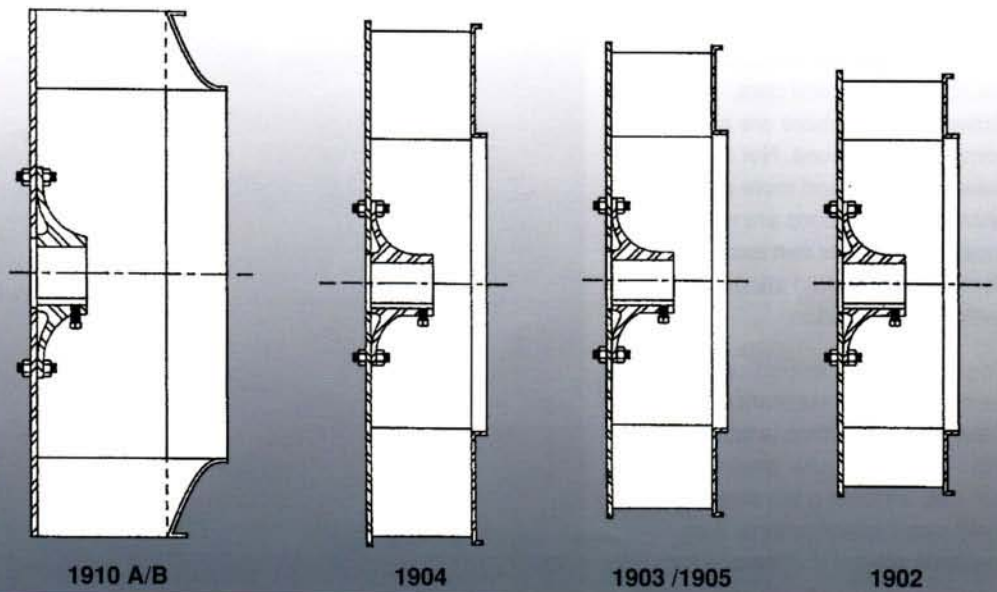
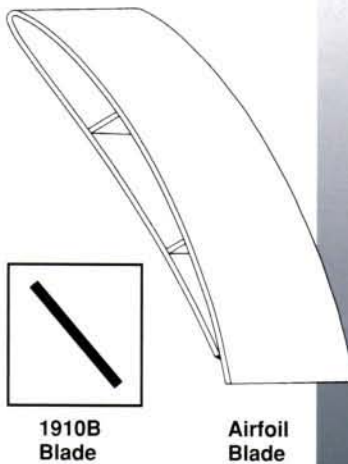

NOTE: All airfoil and backward inclined wheels above are available as DIDW.

### BACKWARDLY CURVED DESIGNS

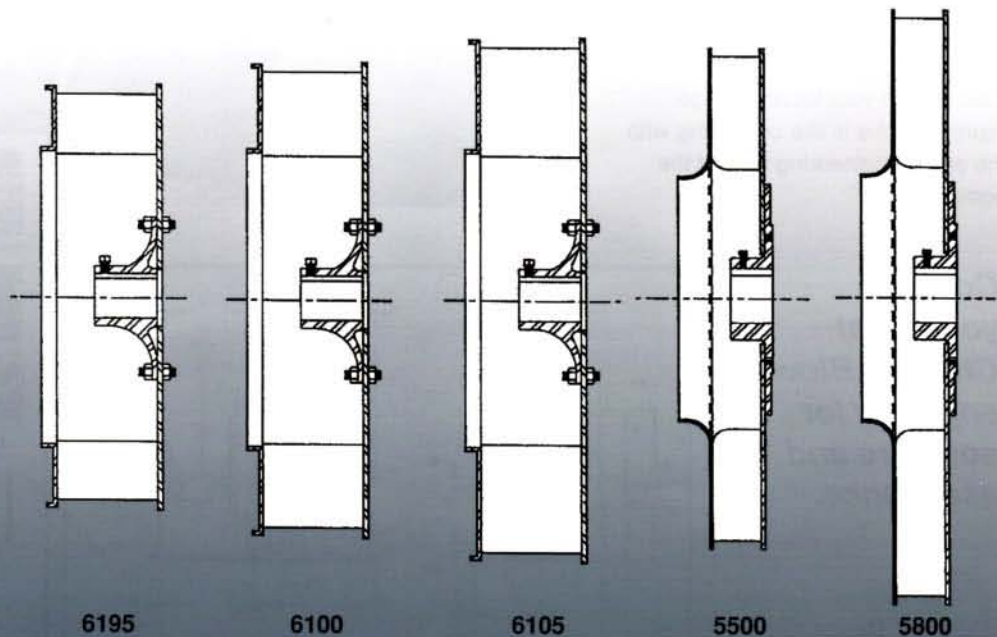
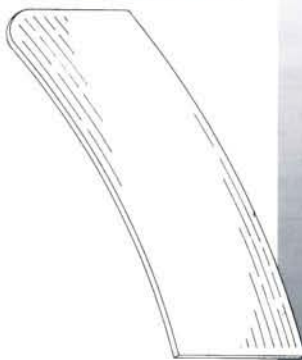



# CHICAGO'S UNIQUE COMPUTER PROGRAMS

## Greater Design Speed and Accuracy

As no two systems are exactly alike, no two fans should be exactly alike. That's why Chicago maintains the most comprehensive in-depth computer programs in the industry. Selection data, performance curves, sound data, physical data, dimensions and more are all computer processed. Not only is fan selection faster and more accurate, alternative selections are readily available. Options can easily be itemized and quoted separately for further consideration.

To provide more immediate and personal design assistance, every Chicago Sales Office is tapped into this unique computer program and can custom tailor a fan selection to meet exact specifications. Also available are fan dimensions for most fan arrangements and various inlet and discharge positions, valuable when fitting equipment into the design space.

Talking with your local Chicago representative is like conferring with the entire engineering staff of the home office.



**Contact your local Chicago Blower engineer for software and assistance.**

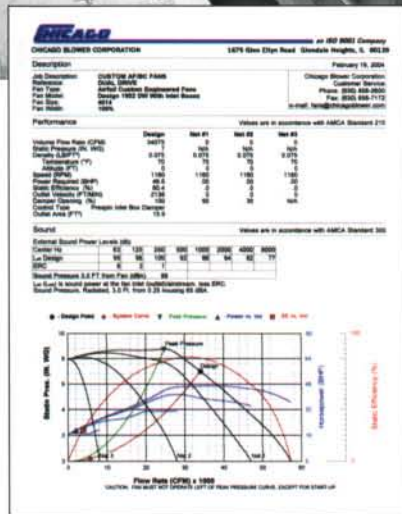
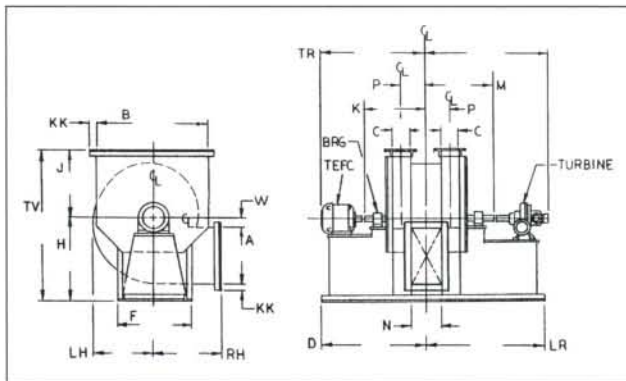

# AF/BC FANS

AIRFOIL & BACKWARDLY CURVED



Fans designed for field erection are first fully assembled at the factory to guarantee accurate fit-up at the jobsite.



A.



B.



C.



D.

A. Chicago builds their own inlet vane assemblies adding construction and control features to match each application.

B. Packaged arrangements allow single piece shipments and dramatically reduce installation time and cost.

C. In-house fabrication allows for better quality control.

D. Rotatable fixtures assure uniform positioning and welding.

**COMPLETE  
SERVICE  
FROM  
DESIGN TO  
START-UP**



Insulated and steel clad fans, ready for installation and operation.

## CHICAGO OFFERS CHOICE OF ARRANGEMENTS

The choice of fan arrangements is determined by installation requirements and the size of the motor or turbine. Because there is an extensive range of needs, Chicago offers all the arrangements shown here.

Discharge orientation varies with the individual installation. The angle of the discharge, rotation of the wheel and the angle of the inlet box must all be established prior to construction. Chicago Airfoil and Backwardly Curved Fans can be built with any combination of rotation, discharge and inlet box.

Application and installation assistance is available from experienced heavy duty fan engineers. For all your industrial fans, make Chicago your source.

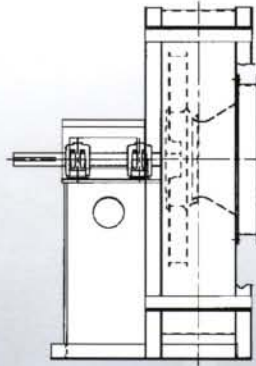

**ARRANGEMENT 1**

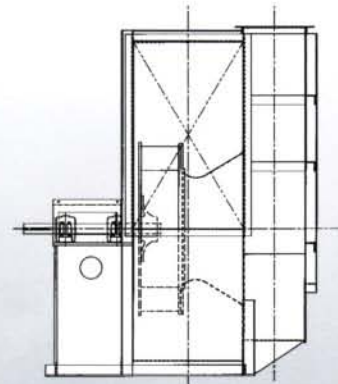

**ARRANGEMENT 1S1**

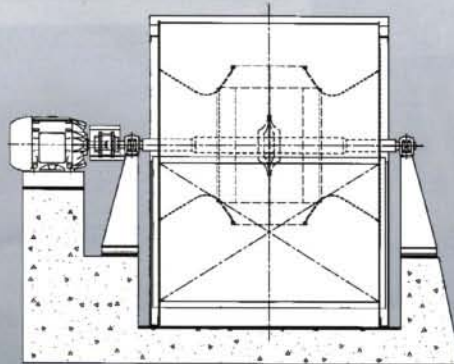

**ARRANGEMENT 3D**

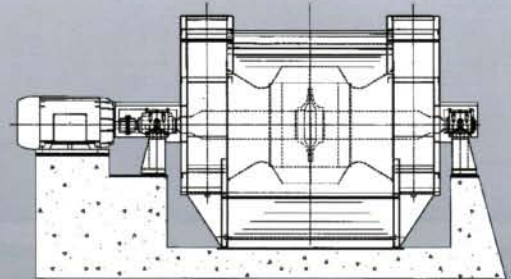

**ARRANGEMENT 3D2**

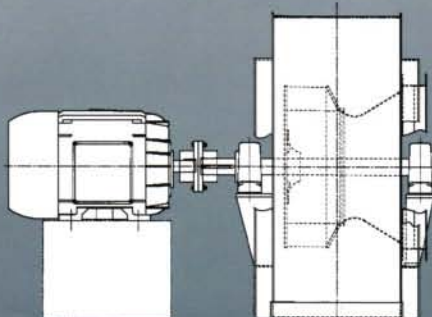

**ARRANGEMENT 3S**

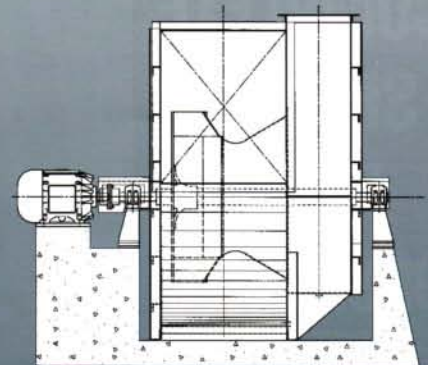

**ARRANGEMENT 3S1**

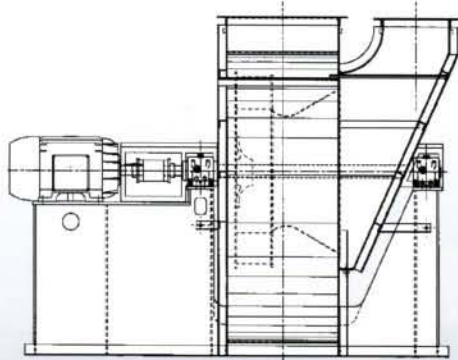

**ARRANGEMENT 7S1**

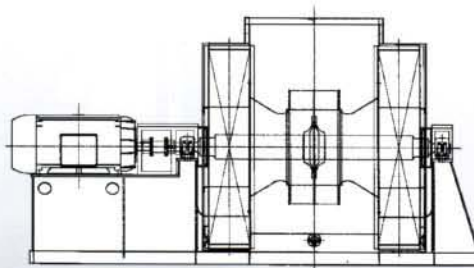

**ARRANGEMENT 7D2**

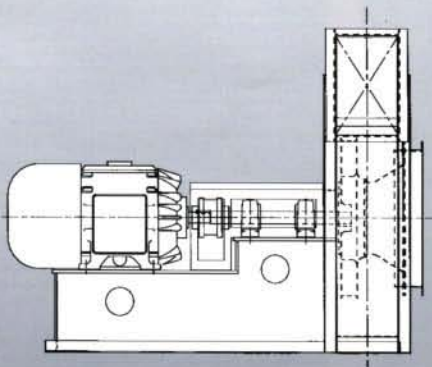

**ARRANGEMENT 8**

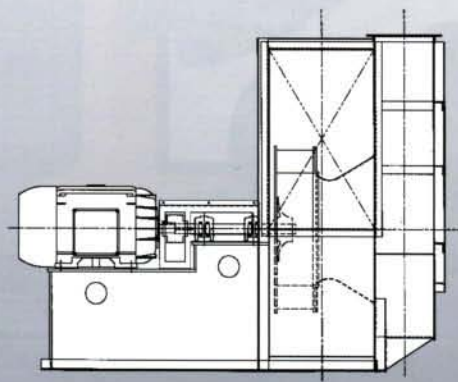

**ARRANGEMENT 8S1**

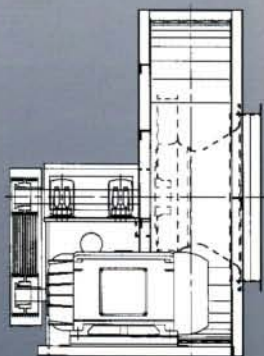

**ARRANGEMENT 9H**

## ROTATION AND DISCHARGE DESIGNATION

Direction of rotation and discharge are viewed from the drive side of the fan. On dual driven units, the drive side is always the higher horsepower drive.

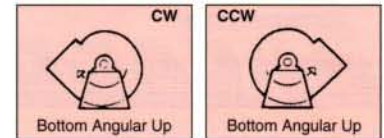
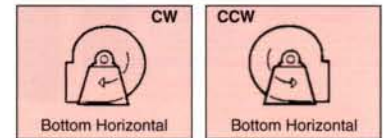
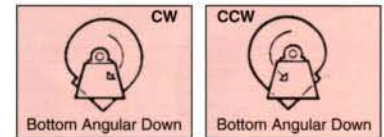
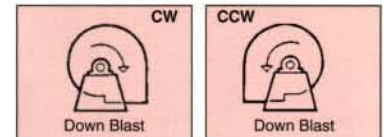
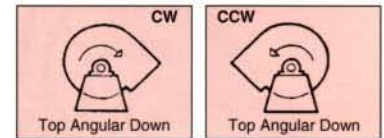
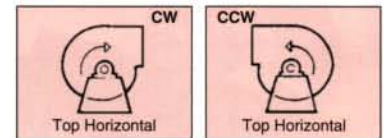
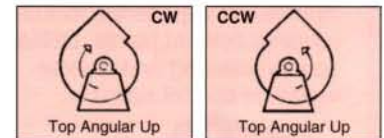
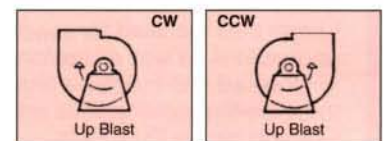

## INLET BOX POSITIONS

Positions are always determined from the drive side of the fan.

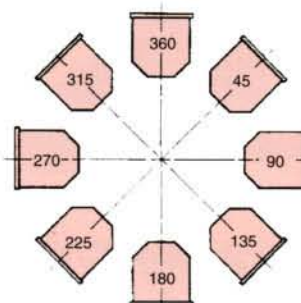

*Setting the  
Standard  
For Quality*

**CHICAGO**

*Innovative Engineering  
Through Application Analysis*



*Quality Fans  
Shaped With  
Skill and Pride*



*Global Service Only a  
Click Away*

**Sales Offices  
Throughout  
North America**

*Chicago Blower Fans  
are also manufactured  
worldwide:*

Argentina, Australia, Brazil,  
Chile, China, Colombia,  
Denmark, Germany, Greece,  
Holland, Hong Kong, India,  
Indonesia, Israel, Italy,  
Japan, Korea, Malaysia,  
New Zealand, Norway,  
Philippines, Portugal,  
Saudi Arabia, Singapore,  
South Africa, Spain, Sweden,  
Thailand, Taiwan, Turkey,  
Venezuela.



***Your Primary Source For Every Fan Requirement***

**General Duty -**

*Airfoil and vane axial  
fans for clean exhaust  
or supply air*

**Industrial Duty -**

*Fans to handle  
dirty and corrosive  
environments*

**Heavy Duty -**

*Custom engineered  
fans for specific  
applications*

**CHICAGO BLOWER  
CORPORATION**

1675 Glen Ellyn Road, Glendale Heights, Illinois 60139

Phone: 630-858-2600 • Fax: 630-858-7172

www.chicagoblower.com e-mail: fans@chicagoblower.com